



Character:

- Only impulse excitation is needed, both for single and double coil.
- Low power consumption with great load capability.
- Accessories can be welded upon customers' requirement
- Dimension: 52×43×22 (mm)

Contact parameter

Contact form	1B	
Contact resistance	Max.1.0mΩ(1A 6VDC)	
Contact material	Silver alloy	
Contact rating (resistive load)	100A 250VAC	120A 250VAC
Max. Switching Voltage	250VAC	
Max. Switching Current	100A	120A
Max. Switching Power	25KVA	30KVA
Life	Mechanical life	5×10 ⁵ OPS
	Electrical life	1×10 ⁴ OPS
Max. Short-circuit current	3000A /10ms	3600A /10ms

Performance parameter

Operate Time	30ms Max	
Release Time	30ms Max	
Relative humidity	45%-90%RH	
Dielectric strength	Coil&contact	4000VAC 50/60Hz(1Min)
	Between opencontacts	2000VAC 50/60Hz(1Min)
Insulation resistance	500MΩ Min.(500VDC)	
Ambient temperature	-40°C ~ +70°C	
Impulsion	98m/s ²	
Vibration	10-55HZ,1.5mm	
Weight(without accessorise)	68g	

Coil parameter(20°C)

Rated coil (VDC)	Coil resistance(Ω)±10%		Coil power (W)		Operate voltage (VDC)	Release voltage (VDC)	Over voltage (VDC)	Impulse duration (ms)
	Single coil	Double coil	Single coil	Double coil				
6VDC	12	6/6	3.0W	6.0W	≤75%	≤75%	≤150%	≥90ms
9VDC	27	13.5/13.5						
12VDC	48	24/24						
24VDC	192	96/96						
48VDC	768	384/384						

Ordering information

HRT1-120A	100A	1B	12VDC	S	XX	
						Connect accessories: As requirement
						Coil type: S:single coil D:double coil
						Coil voltage: 6,9,12,24V
						Contact form: 1B:a set of contacts remains closed
						Contact current : 100A,120A
						Type: HRT1-120A

Dimension , wiring diagram(unit:mm)

Single coil

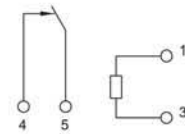
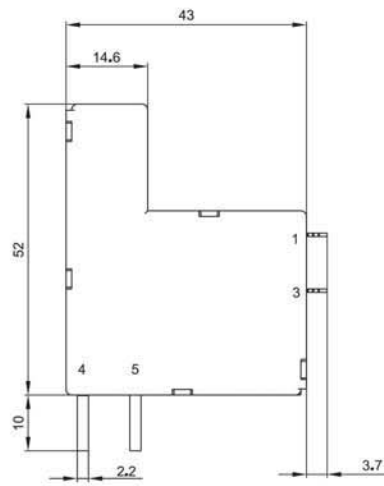
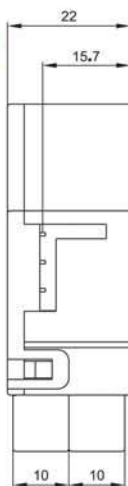

1(+)|3(-) 4-5Release (Open)
3(+)|1(-) 4-5Operate (Close)

Double coil

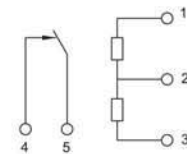
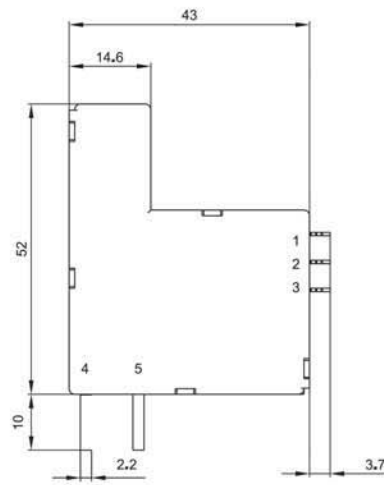
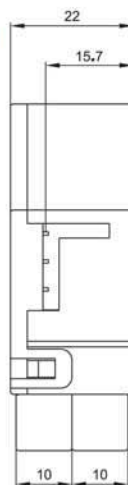

1(+)|2(-) 4-5Release (Open)
3(+)|2(-) 4-5Operate (Close)

Note : No tolerance marked. When dimension is $\leq 1\text{mm}$, the tolerance shall be ± 0.2 ; when dimension is $1-5\text{mm}$, the tolerance shall be ± 0.3 ; when dimension is $> 5\text{mm}$, the tolerance shall be ± 0.5 .

Schematic diagram of a typical specification(unit:mm)

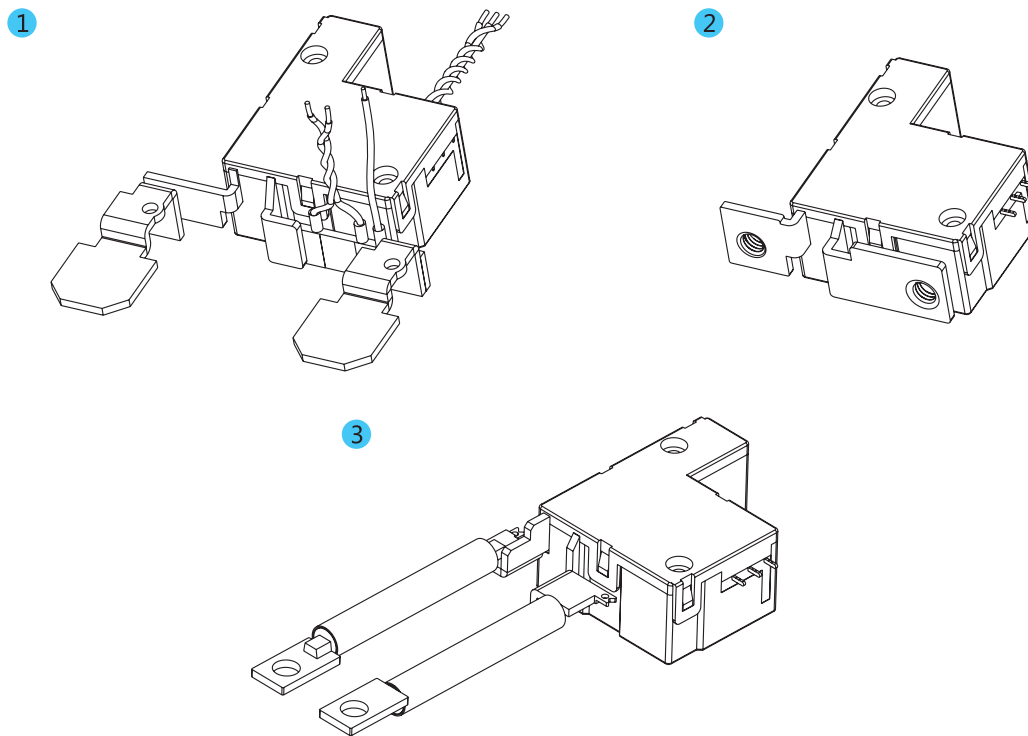

Typical application

- smart meter
- power composite switch

Notice

- 1、 The factory default of the contacts is to stay closure (reset), It's possible that the status will be changed with impact during shipment or installation. Please make sure the status of the contacts stay reset before using.
- 2、 To guarantee the latching relay operates reliably, the excitation voltage to coil should meet the rated value and impulse duration needs to exceed 3 times of the operation time. For double coil type latching relay, please neither apply voltage signal to both coils at the same time nor apply with long time (over 1 min).
- 3、 Latching relays without copper braided wires, the loaded PIN can neither be tin soldered nor be wrenched. Rigid fixing of the two pins is also not allowed.
- 4、 Magnetic latching relay is polarized relay. If customer needs different kinds of polarity from the data sheet, please inform us.
- 5、 Please handle the latching relays with care during factory's incoming-inspection and when put in use, do not let the relay drops which will impact the parameter. Please make strict distinction between relay made for.