



Character:

- Contacts can be controlled (switched) by the paddle.
- Low power consumption with great load capability
- Accessories can be welded upon customers' requirement.
- Dimensions: 36.6x30x18 (mm)

Contact parameter

Contact form	1B	
Contact resistance	Max. 1.5mΩ(1A 6VDC)	
Contact material	Silver alloy	
Contact rating (resistive load)	60A 250VAC	80A 250VAC
Max. Switching Voltage	250VAC	
Max. Switching Current	60A	80A
Max. Switching Power	15KVA	20KVA
Life	Mechanical life	5×10 ⁵ OPS
	Electrical life	1×10 ⁴ OPS
Max. Short-circuit current	1800A/10ms	2400A/10ms

Performance parameter

Operate Time	20ms Max	
Release Time	20ms Max	
Relative humidity	45%-90%RH	
Dielectric strength	Coil&contact	4000VAC 50/60Hz(1Min)
	Between opencontacts	1500VAC 50/60Hz(1Min)
Insulation resistance	500MΩ Min.(500VDC)	
Ambient temperature	-40°C~+70°C	
Impulsion	98m/s ²	
Vibration	10-55HZ, 1.5mm	
Weight(without accessories)	45g	

Coil parameter(20°C)

Rated coil (VDC)	Coil resistance(Ω)±10%		Coil power (W)		Operate voltage (VDC)	Release voltage (VDC)	Over voltage (VDC)	Impulse duration (ms)
	Single coil	Double coil	Single coil	Double coil				
6VDC	36	18/18	1.0W	2.0W	≤75%	≤75%	≤150%	≥60ms
9VDC	81	40.5/40.5						
12VDC	144	72/72						
24VDC	576	288/288						
48VDC	2304	1150/1150						

Ordering information

HRT1-80A	80A	1B	12VDC	S	XX	
						Connect accessories: Upon requirement
						Coil type: S:single coil D:double coil
						Coil voltage: 6,9,12,24,48V
						Contact form: 1B:a set of contacts remain closed
						Contact current : 60A,80A
						Type: HRT1-80A

Dimension 、 wiring diagram(unit:mm)

Single coil

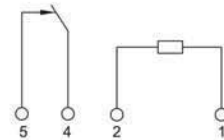
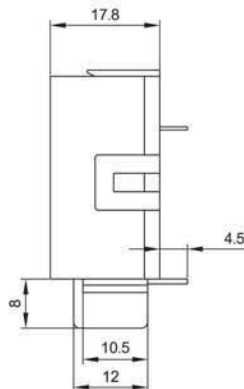
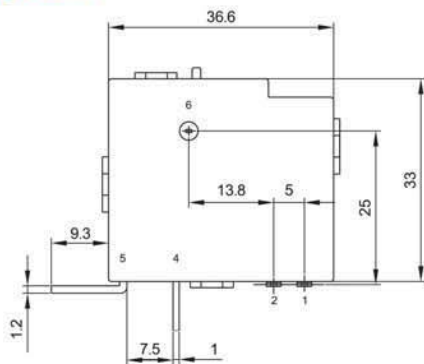

1(+)-2(-) 4-5Release (Open)
 2(+)-1(-) 4-5Operate (Close)
 6Positioning Pin (Optional Choice)

Double coil

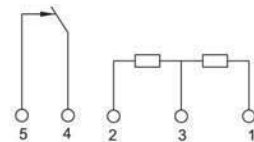
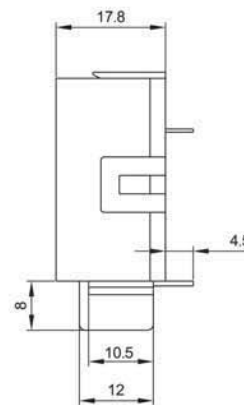
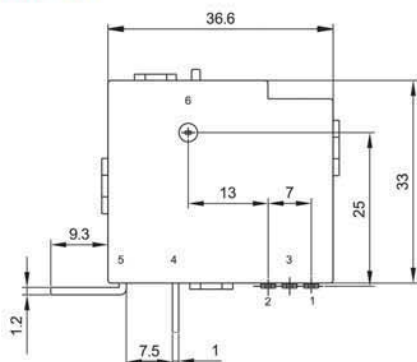

1(+)-3(-) 4-5Release (Open)
 2(+)-3(-) 4-5Operate (Close)
 6Positioning Pin (Optional Choice)

Note: No tolerance marked. When dimension is $\leq 1\text{mm}$, the tolerance shall be ± 0.2 ; when dimension is 1-5mm, the tolerance shall be ± 0.3 ; when dimension is $> 5\text{mm}$, the tolerance shall be ± 0.5 .

Schematic diagram of a typical specification(unit:mm)

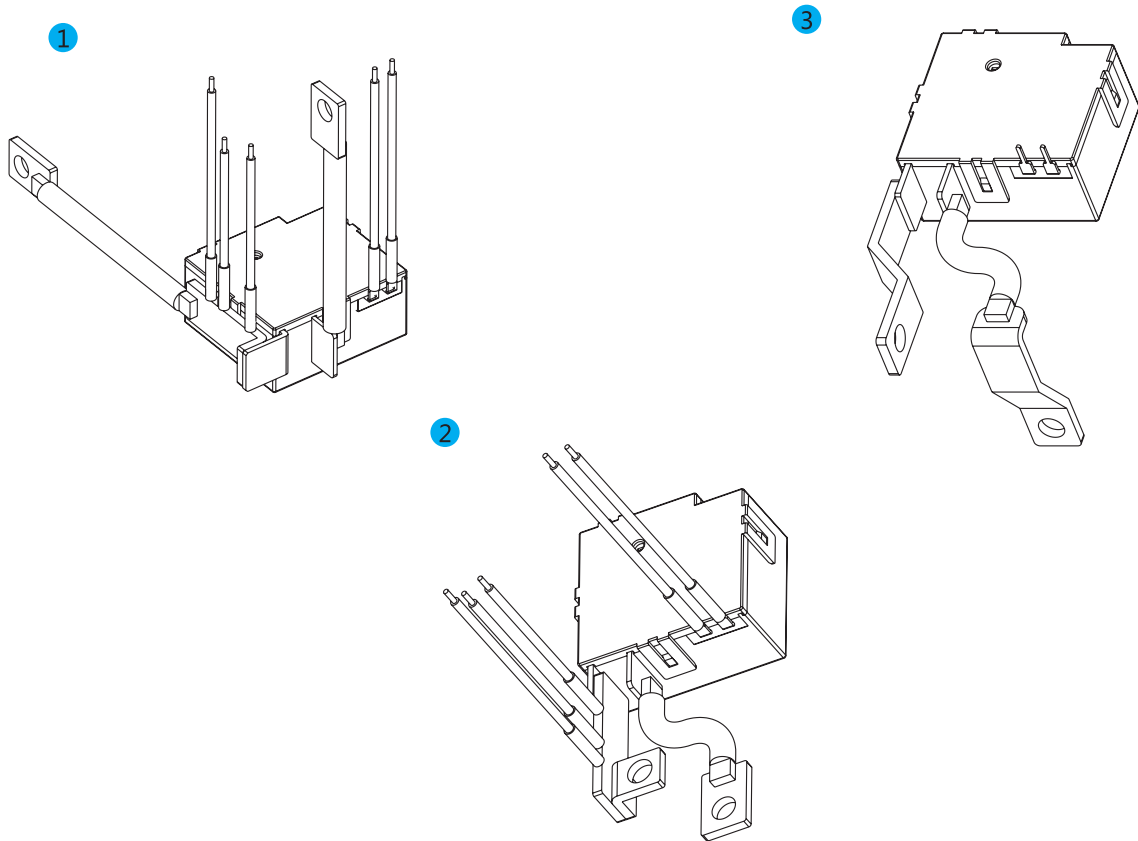

Typical application

- smart meter
- power composite switch

Notice

- 1、 The factory default of the contacts is to stay closure (reset), It's possible that the status will be changed with impact during shipment or installation. Please make sure the status of the contacts stay reset before using.
- 2、 To guarantee the latching relay operates reliably, the excitation voltage to coil should meet the rated value and impulse duration needs to exceed 3 times of the operation time. For double coil type latching relay, please neither apply voltage signal to both coils at the same time nor apply with long time (over 1 min).
- 3、 Latching relays without copper braided wires, the loaded PIN can neither be tin soldered nor be wrenched. Rigid fixing of the two pins is also not allowed.
- 4、 Magnetic latching relay is polarized relay. If customer needs different kinds of polarity from the data sheet, please inform us.
- 5、 Please handle the latching relays with care during factory's incoming-inspection and when put in use, do not let the relay drops which will impact the parameter. Please make strict distinction between relay made for.